

TIDES HINGE DOOR

Installation Manual

IMPORTANT: Record the Model No.(see carton) of your tub or shower enclosure for future reference.





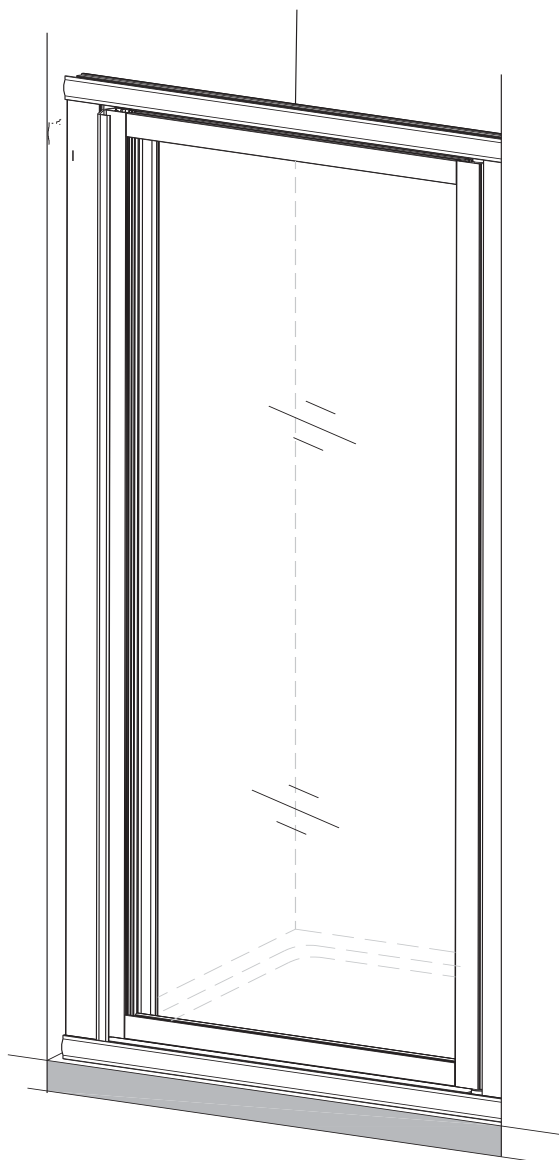

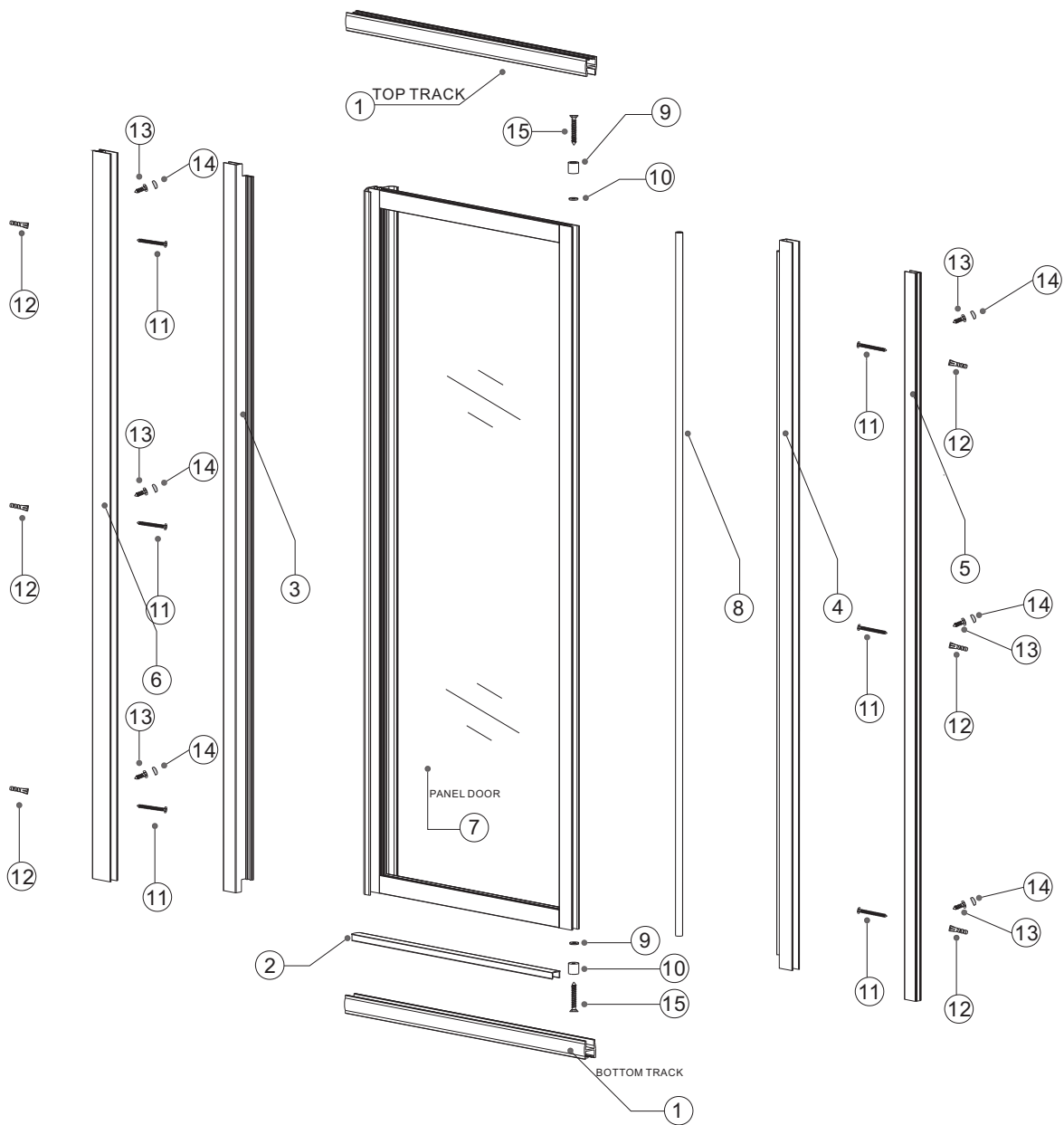





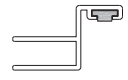
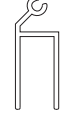

Model No. _____

READ THE INSTRUCTIONS CAREFULLY, familiarize yourself with all the parts as shown in the exploded view. The exploded view will also provide a helpful reference when relating to the location of the various parts and how they are mounted.









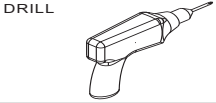

• PART LIST.

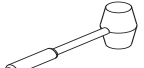
				
TOP / BOTTOMTRACK (2 Pcs)	BOTTOM CAP (1 Pcs)	MAGNET JAMB (1 Pcs)	PIVOT JAMB (1 Pcs)	WALL JAMB (1 Pcs)
				
WALL JAMB (1 Pcs)	PANEL DOOR (1 Pcs)	PLASTIC PIVOT (1 Pcs)	BUSHING (2 Pcs)	GASKET (2 Pcs)
				
4 x 38mm SCREW (6 pcs)	WALL PLUG (6 pcs)	4 x 12mm SCREW (9 pcs)	SCREW CAP (9 pcs)	4 x 35mm SCREW (2 pcs)

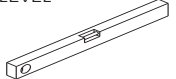
• TOOLS.

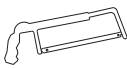

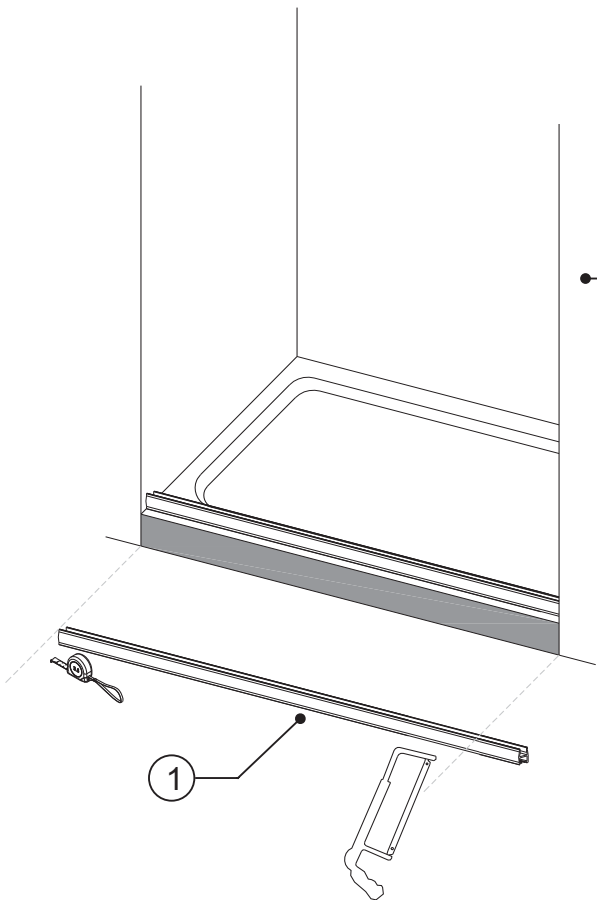
STEP 1

INSTALL BOTTOM TRACK

1

CUT TO EXACT OPENING SIZE

STEP 2

INSTALL LEFT WALL JAMB AND RIGHT WALL JAMB

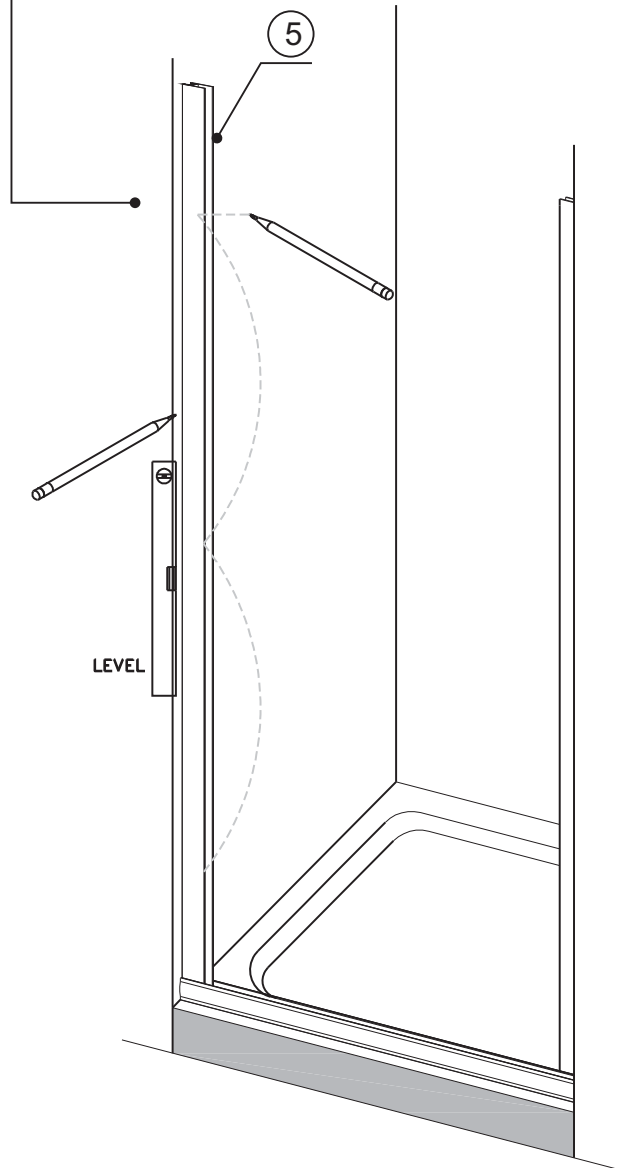

5

LEVEL

12

WALL PLUG

11

SCREW

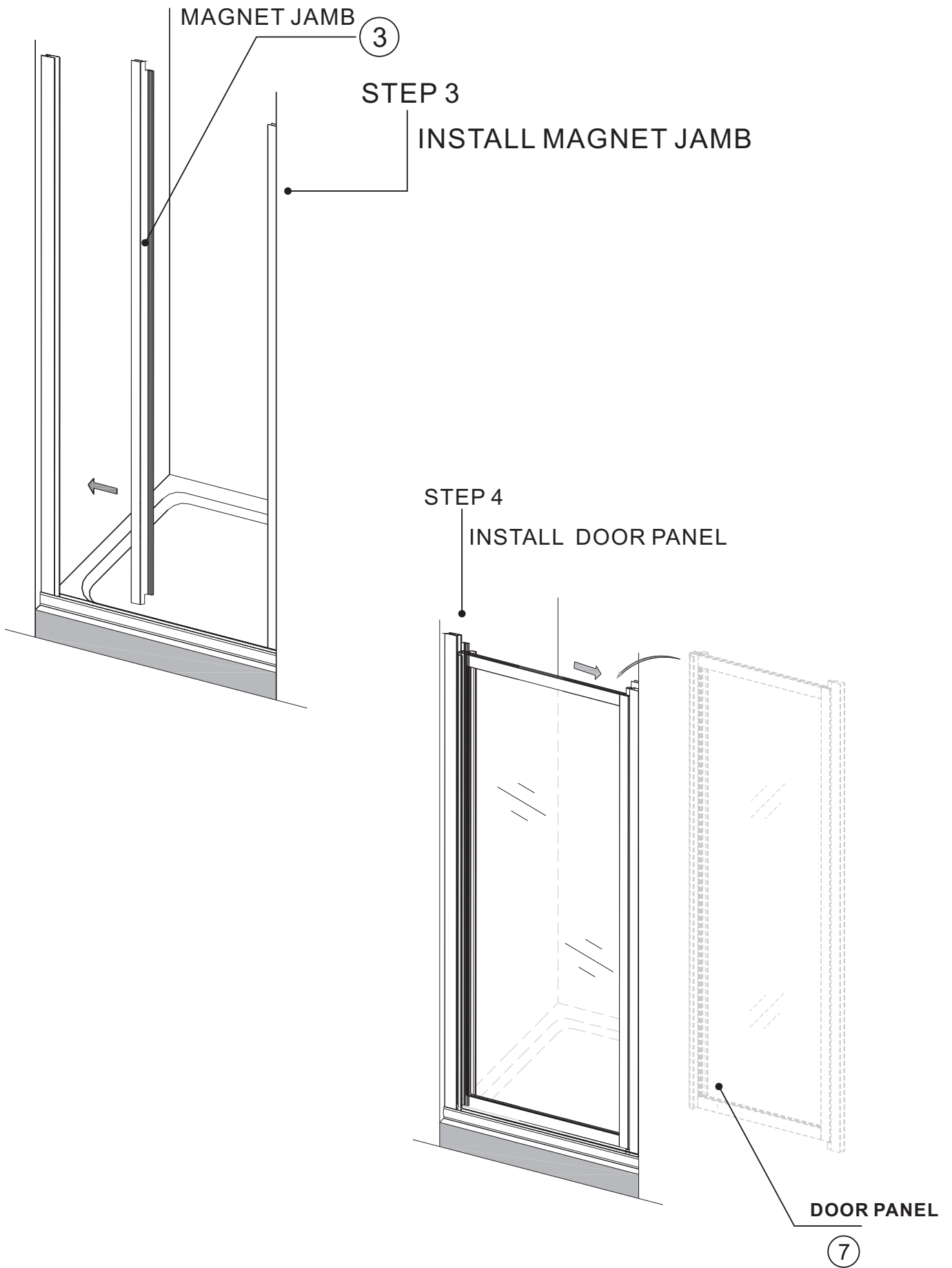

STEP 5 INSTALL SCREW AND SCREW CAP

AFTER A AND B ADJUSTMENT, TIGHTEN SCREW #14 ON ALL PIECES THROUGH SLOTS AND INTO HOLES, COVER WITH SCREW CAPS #14

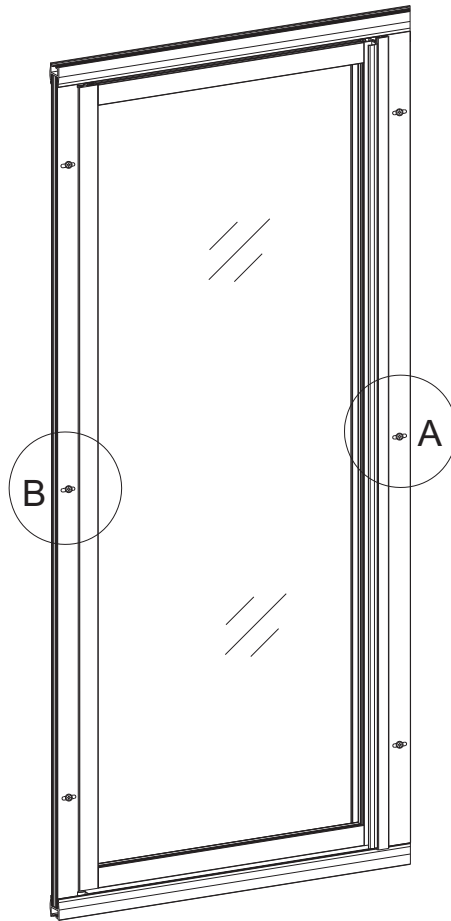
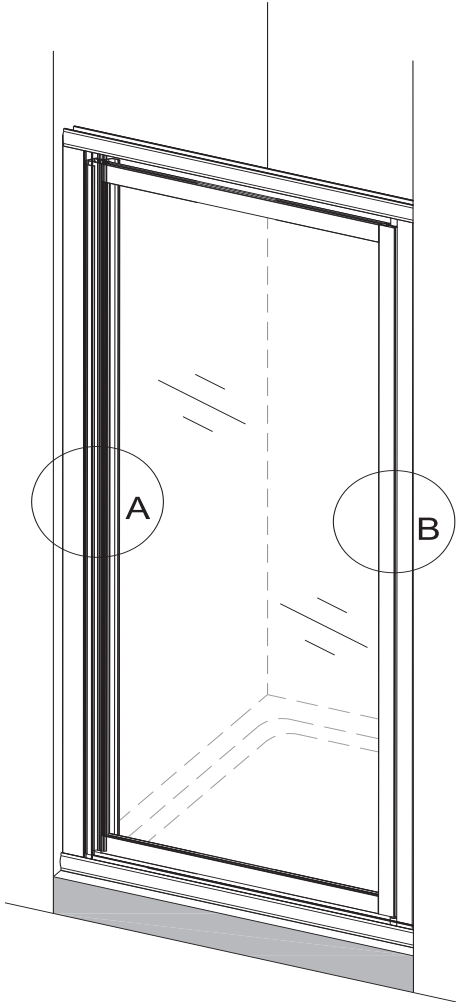

DETAILED - A
SIDE VIEW

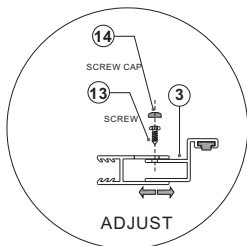

DETAILED - B
SIDE VIEW

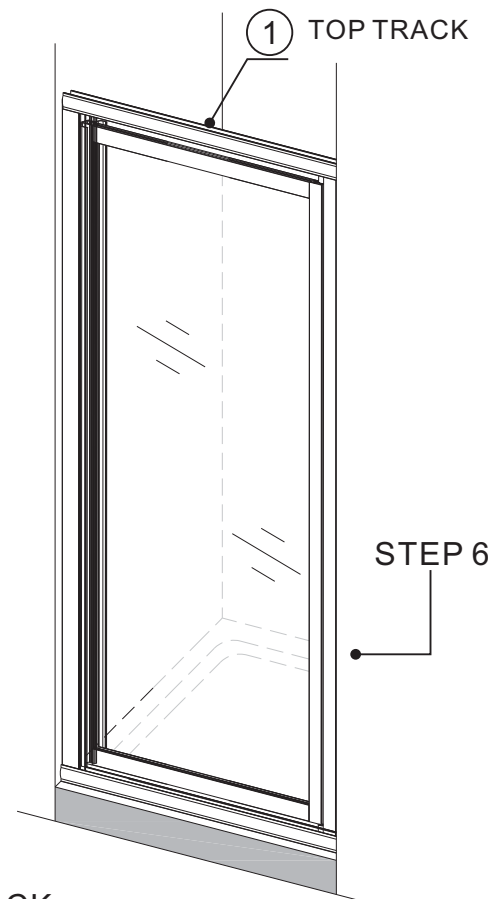
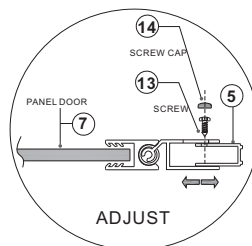

INSTALL TOP TRACK



24 Hours

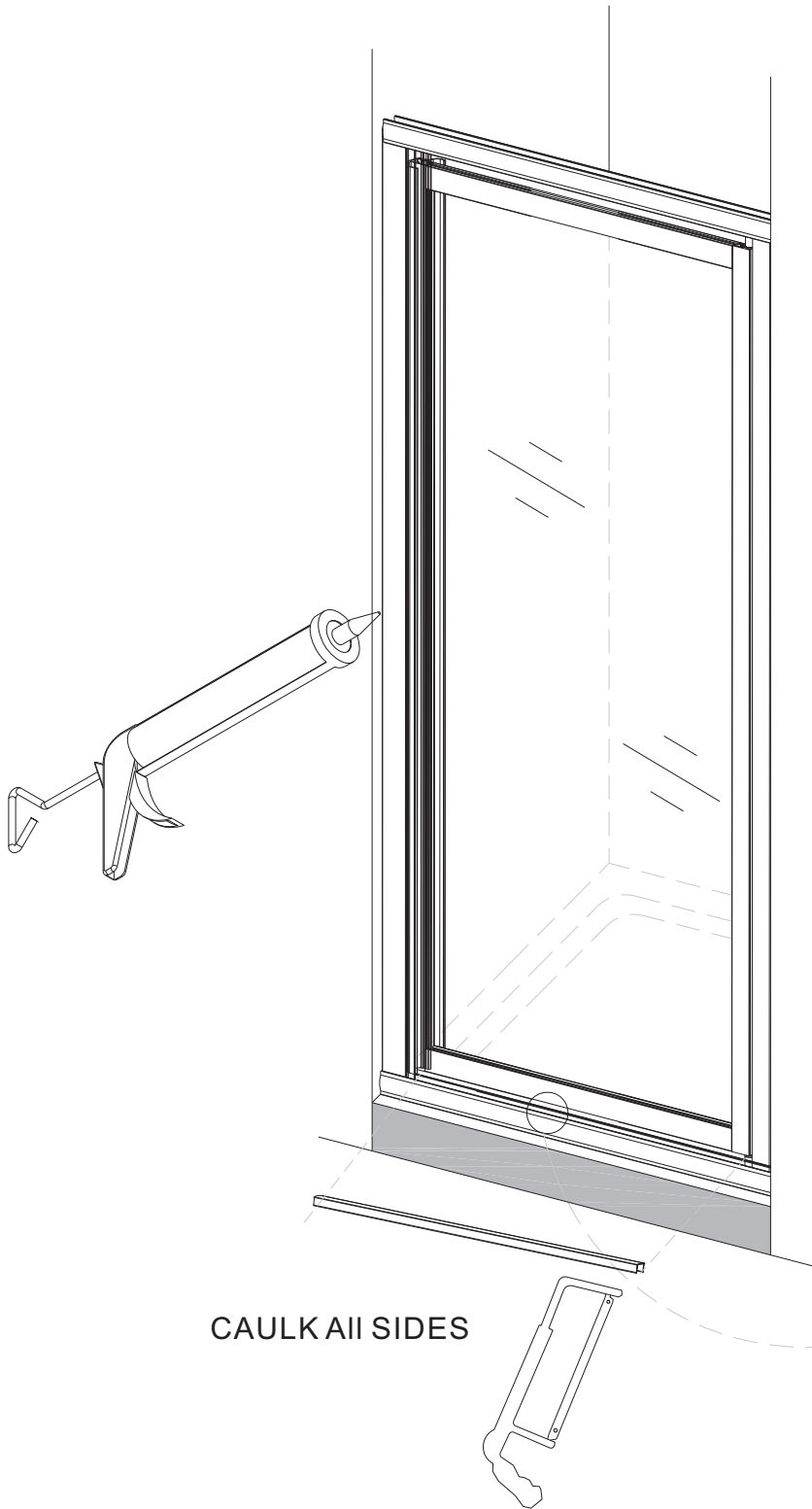

CAULK ALL SIDES

STEP 8
INSTALL BOTTOM CAP

